



Equipment Solution Group Colombia S.A



Integral Solutions ESGCOL





1 - Drilling Perforation

Well Heads & Choke Valves: Oil & Gas

Manufacturer

Production Chokes & Well Heads

Extreme Service Chokes

Wellhead Hydraulic Control System & Injection Pumps

Hydraulic – Pneumatic – Electric Local
Control Panel for Valves.

Compact Manifold Valves

BOP Testing Units.

API 6A - ASME CHOKE VALVES / Flow Line Accessories.

Skidded Units for, Glycol, IMethanolInhibitor.



HYDROPNEUMATIC



Italy



2- OIL / GAS Production

EPC Company

- Steam Generators (HRSG) – Waste Heat Boilers (WHB) & Waste Heat Recovery Units.
- Refinery Projects: Topping Units – Isomerization Units – Catalytic Reforming Units – Naphtha Hydrotreatment Units Hydrocracker Units – Gasoline Trains.
- Gas Gathering and Compression Station – Gas Conditioning & Transportation Projects - Gas Processing Plants. Natural Gas Conditioning & Storage Process



Spain



2- OIL / GAS Production

Separation Technologies

Manufacturer

Computational Fluid Dynamics

- Gas-Liquid-Liquid Separators
- Gas-Liquid Separators
- Liquid-Liquid Separators
- Refinery Revamping

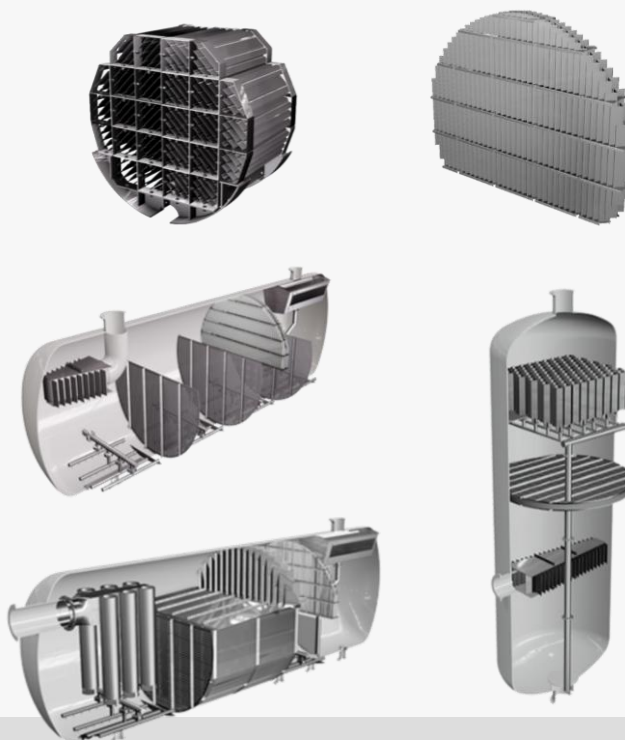

 Costacurta



Italy



3 - Piping, Fittings and Transportation

Manufacturer

- Hydrocarbons Loading Arms
- Chemical Loading Arms
- LPG Loading Arms
- Hot Products Loading Arms
- Food Sciences Loading Arms



Italy



3 - Piping, Fittings and Transportation

Pipelines & Accessories

Manufacturer

Applications:

Off-shore, On – Shore, Oil & Gas transmission,
Inox Tech Manufactures: St. St. Duplex, Super
duplex, Nickel Alloys, Clad & Others Exotic
Materials

- UNI EN ISO 3834 – DNV – PED - API 5L, 5LC, 5LD, 5CT, A671, Q1, OHSAS 18001, ISO 14001



SēAH



South Korea



3 - Piping, Fittings and Transportation

Flexible Pipelines

Manufacturer

Applications:

Crude Oil – LPG – Natural Gas – Steam
– Petrol Pump – Solvents – Chemical –
Petrochemical – Pharmaceutical

Products:

Rubber Expansion Joints – Couplings –
Pipe Couplings – Swivels - Flexible
Pipe Line

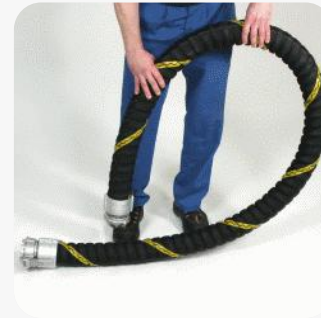

Germany

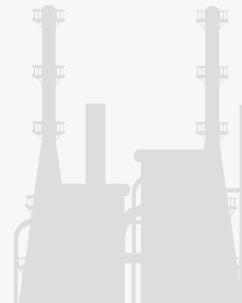

3 - Piping, Fittings and Transportation

Pipelines & Accessories

Manufacturer

Pipelines elbow / Pipelines tees / Caps
/ Bends / Fittings

Carbon Steel / Stainless Steel / Rating
up to API 3000 / Concentric &
eccentric reducer

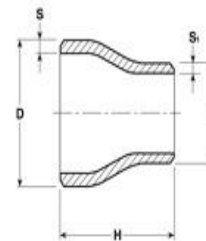

Italy



3 - Piping, Fittings and Transportation

Pipelines & Accessories

Manufacturer

Certifications:

UNI, EN, API, BS, DIN, ASME, MSS.SP,
AWWA, ASIM, AFNOR, ANSI, MSS, NACE

Products:

Forged Flanges / Orifice Flanges /
Spectacle Flanges / Drip Rings

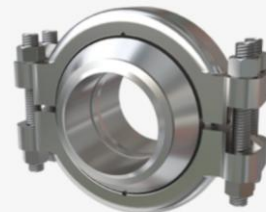

Italy



3 - Piping, Fittings and Transportation

Studs & Nuts

Manufacturer

Threaded Bar, Hex Nuts / Headed Product

Finished Stud bolt & Nut assemblies available from stock in carbon steel, stainless steel, duplex / super duplex and exotic alloys



United
Kingdom

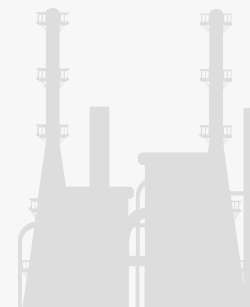

3 - Piping, Fittings and Transportation

Valves: Oil, Gas & Industries

Manufacturer

Globe Valves / Axial Flow Control Valves / Sub Sea Valves / LNG Ball Valves / Choke Valves

Check Valve: Swing - Dual Plate - Axial & Nozzle.

Ball Valve: Top Entry – Side Entry - Fully Welded – Rising Stem.

Gate Valves: Slab – Double Expanding – Flexible Wedge – Through Conduit.

Certifications: SIL 3 – TUV - ISO 9001-2008 – PED - API 6A API 6D - API 6DSS - API 17D



ATV ADVANCED
TECHNOLOGY
VALVE



Italy



3 - Piping, Fittings and Transportation

Valves: Oil, Gas & Industries

Manufacturer

Certifications:

API 600-0200 / API 594-0034 / API 6D-0166 / API 6A-0992 / API 622 / API 624 / AD 2000 / VDI 2440

Products:

Gate Valves / Globe Valves / Check Valves / Strainers / Valvosider – Power / Stock Materials



ASME

150 ÷ 1500 LBS
NPS 2" ÷ 16"

DIN

PN 6 ÷ 250
DN 15 ÷ 400



ASME

150 ÷ 1500 LBS
NPS 2" ÷ 24"

DIN

PN 6 ÷ 250
DN 50 ÷ 600



ASME

150 ÷ 2500 LBS
NPS 2" ÷ 48"

DIN

PN 6 ÷ 420
DN 50 ÷ 1200



ASME

150 ÷ 2500 LBS
NPS 2" ÷ 48"

DIN

PN 6 ÷ 420
DN 50 ÷ 1200



ASME

150 ÷ 1500 LBS
NPS 2" ÷ 42"

DIN

PN 6 ÷ 320
DN 50 ÷ 1050

VALVOSIDER
MANUFACTURER OF VALVES



Italy

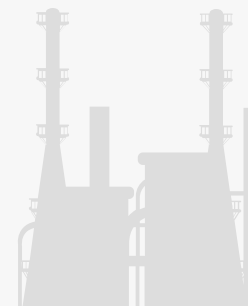

3 - Piping, Fittings and Transportation

Plug Valves: Gas, Oil & Industries

Manufacturer

Certifications:

API 6D - API 6A - API 599 - BS5353 / ANSI
B16.10 - BS 2080, ASME B16.34 - ISO15848-
1/2 - BS EN 14141 - ASME B16.5 - Low
Fugitive Emission ISO 15848 PEA

Manufacturer:

Plug Valves Lubricated / Double Block &
Bleed / Double isolation valve / Pressure
Seal Valves

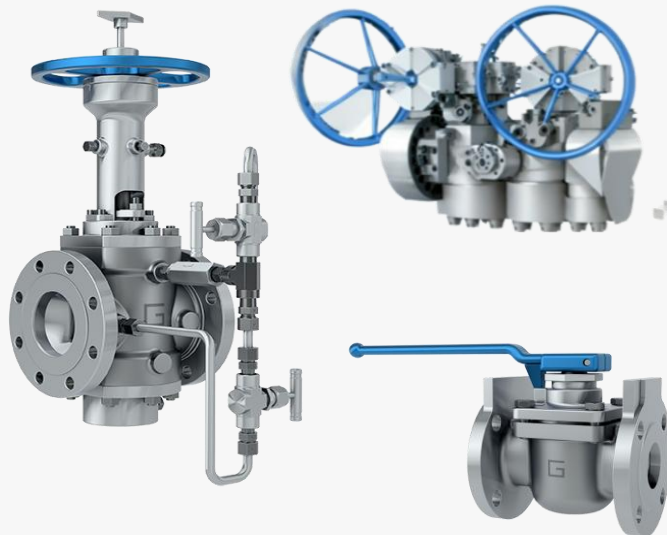

GALLI & CASSINA
Plus Valves
SINCE 1919



Italy

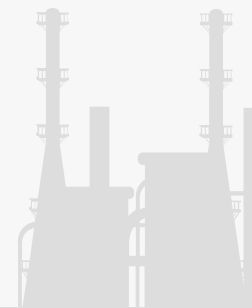

3 - Piping, Fittings and Transportation

API 608 Ball Valves

Manufacturer

Certifications:

API – 608

- Monoblock Ball type Valves
- Split body Ball Valves
- Needle Valves
- Sizes from ½' up to 6'
- Ratings 150 - 300 - 600 - 800 - 1500 - 2500 - 4500 - 6000 & API 1000 - 15000



C.V.L. Valvole a sfera



Italy

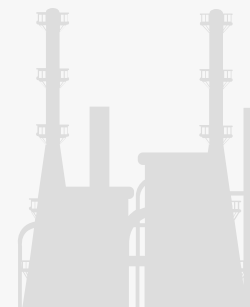

3 - Piping, Fittings and Transportation

API 608 Ball Valves

Manufacturer

- Needle Valves & Manifolds
- Double Block & Bleed Valves
- Monoflange Valves
- Monoblock Valves
- Calibration Equipment
- Positioners
- Injection/Sampling DBB
- API Monoflanges



 Budenberg



United
Kingdom



3 - Piping, Fittings and Transportation

API 602 Valves: Gate, Check & Globe

Manufacturer

- Gate Valve / Globe Valve / Check Valve / Piston Check Valve / Swing Check Valves
- **Classes:** 150 - 300 - 600 - 800 - 1500 - 2500 - 4500 / API 10000 - API 15000 / API - 602
- **Sizes:** From ¼' to 4'
- **Ends:** Socket Welding: ASME B16.11 / N.P.T: ASME B1.20.1 / Butt Welding: ASME B16.5 / Integrally Flanged: ASME B16.10 & ASME B16.5
- Special clamp
- **Execution:** Bolted & Welded bonnet - Pressure seal - Reduce & Full port, Bellows seal - Cryogenic

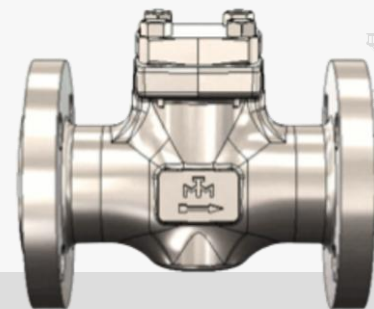
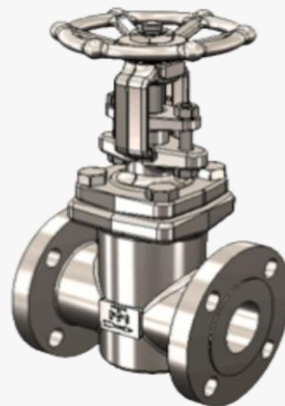

Italy

3 - Piping, Fittings and Transportation

API 602 Valves: Gate, Check & Globe

Manufacturer

- Flanged and threaded inlet form 1' to 8
- PSV Spring operated valves / PSV Pilot operated valves / Pressure ranges 15-2400 psi and 3000-8700 psi.
- Excel spreadsheet sizing applications to help choose the right valve for the job. / Weather caps
- Bleed rings / Rupture discs and holders

9100
Flanged



8100
Threaded



1400
Series



9500
Pilot Operated



United
States of
America

4- Refining and Petrochemicals

Manufacturer



Italy

- **Products:**
Reactors / Shell & Tube Heat Exchangers /
Columns & Towers / Methanol Converter
Hydrocracking Reactor / Sulphur Recovery
Units / Steam Condenser / High Pressure
Vessels/ H₂S Column Stripper / Combustion
Chamber / Casing for turbine



4- Refining and Petrochemicals

STRACK PHONIX

Manufacturer

- Gate – Globe – Piston – Swing Check & Plug Valves.
- For HF – ACID SERVICE & UOP SPECIFICATION
- ALKYLATION VALVES
- Body Material Carbon Steel – Monel – Sealing Surface PTFE – Stem Sealing Monel Sleeve – RF, RTJ, SW & TE



STRACK Armaturenwerke GmbH

PHÖNIX STRACK



Germany

5-Energy Industry and Environment

EPC COMPAY

- Pig launching and Receiving Traps - Gas pressure Reducing Station and Control Units - Skid Mounted Gas, Filtering Regulation, Metering
- Oil/Water Separators (2 or 3 Phase) - Nitrogen Production Systems - Glycol Dehydration Units
- Heating Systems - LNG - LPG Plants. - Odorizing Units
- Filters - LAC Units & City Gas Stations



Spain



5-Energy Industry and Environment

Manufacturer

Mobile: Refueling Tanks - Tank for Fuel
Electricity Generations and Heating Use

Transportable: Steel: For Diesel Fuel/Gasoline In
Polyethylene: Fuel Dispenser Units

Underground: Single & Double Skinned Tank Fuel
Dispenser Units; Management System

AdBlue: Above Ground in Polyethylene AdBlue
Dispenser Fuel Dispenser Units



 **Righetto**
SERBATOI



Italy

6- Automation

DVG Company Automation

Manufacturer

- **Control Instruments:**

Limit Switch Box – Electronic Smart Valve Controller – Partial Stroke Device – Valve Monitoring – Self Contained – Double Pressure Switch – Quick Exhaust – Volume Booster & Filter Regulator Unit.

- **Actuators System Type:**

Pneumatic – Gas Over Oil – Direct Gas – Hydraulic – Electro Hydraulic Compact – Linear Hydraulic & Helical Slot Mechanism

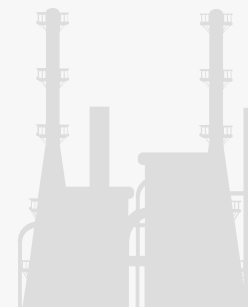
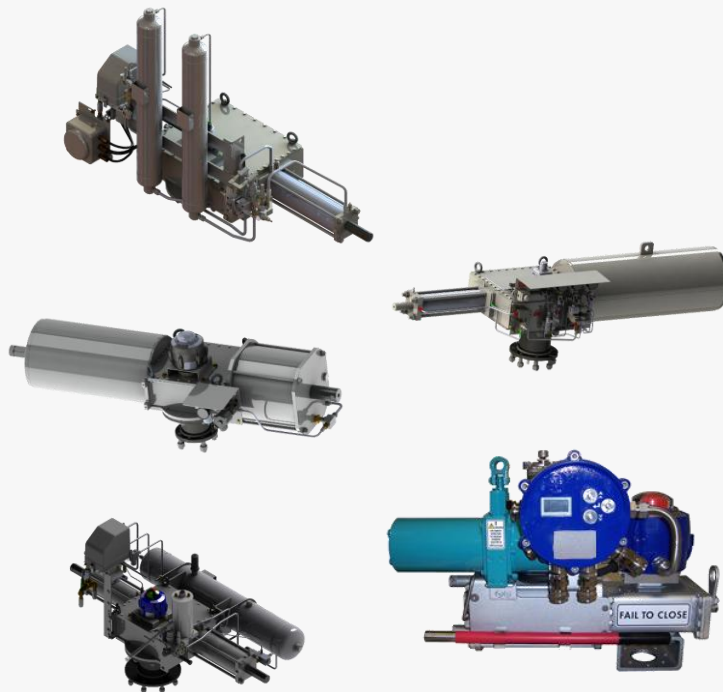

7-Alternative Energy

High Integrity Pressure Protection System (HIPPS)

- 1. INITIATORS
The elements measuring the (over) pressure.
- 2. LOGIC SOLVERS
Safety system that receives the signals from the initiators, performs the required logics and drives the final elements.
- 3. FINAL ELEMENTS
On/Off valves provided with actuators, solenoids and limit switches. Typically valves close to isolates the dangerous pressure source and protect the downstream lines.

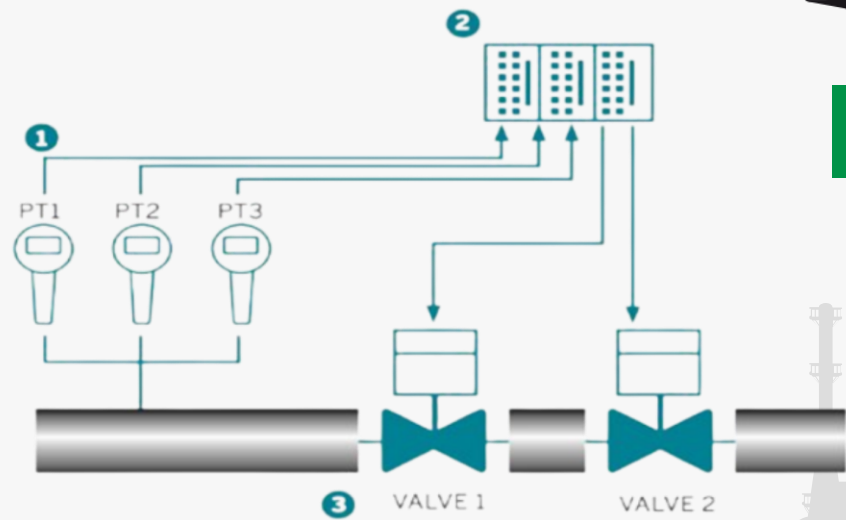

Italy

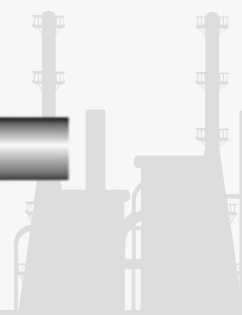

7-Alternative Energy

EPC Company

Hydrogen Systems Plant

Green Energy: Grey & Blue Hydrogen –
 Dynamic Green Ammonia Production
 Modular Plants – Methanol Production
 Units – Energy Transition Projects:
 Recover the Biogenic Co2 coming from
 Biogas PowerPlant to produce Methanol
 employing renewable Hydrogen.
 Hydrogen for Industrial uses, Capture of
 Co2 – Synthetic Hydrocarbons

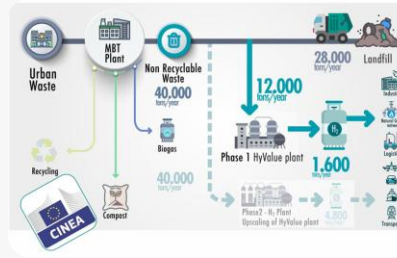

NOVARGI



Spain

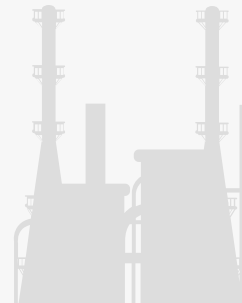

8- Off Shore

Trendsetter Connection Systems & SMART Dual Bore Modules

Scope:

- Sub sea structures – HIPPS Manifolds Modules.
- Connection System and Smart Dual Bore Modules.
- Bespoke Solutions.

Segments:

- Drilling: Capping Stacks – Sub sea isolation devices – BOP adapters.

Production:

- Manifolds – Distribution – Connectors – Intervention on Systems – Mechanical & Hydraulic Abandonment P&A.
- Bespoke Solutions which is foundation of our philosophy.



Noble Gunflint PLETs



ExxonMobil HIPPS



United States of
America



Italy

8- Off Shore

Trendsetter Connection Systems & SMART Dual Bore Modules

• Significant value to end users when no other competitor could meet rigorous cost, technology or schedule challenges such as:

Principal Target:

1. Jumper vibration suppression devices.
2. Jumper Intervention modules.
3. Well head completion adapter
4. Riser guide tube assembly (RGTA)
5. Template slot adapter (TSA)



Pila de tapado Trendsetter de 20 000 PSI



Wellhead / Completion Adapter

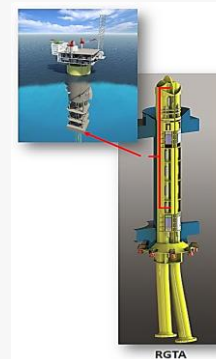

RGTA



Tapa de terminación de cabezal de pozo



United States of
America



Italy



Equipment Solution Group Colombia S.A Integral Solutions

